

# P 120 Duschrinne CeraFloor Select mit Ablaufgehäuse DallFlex

## Shower channel CeraFloor Select with drain body DallFlex

Anschluss seitlich, Verbundabdichtung / Side outlet, under-tile waterproofing

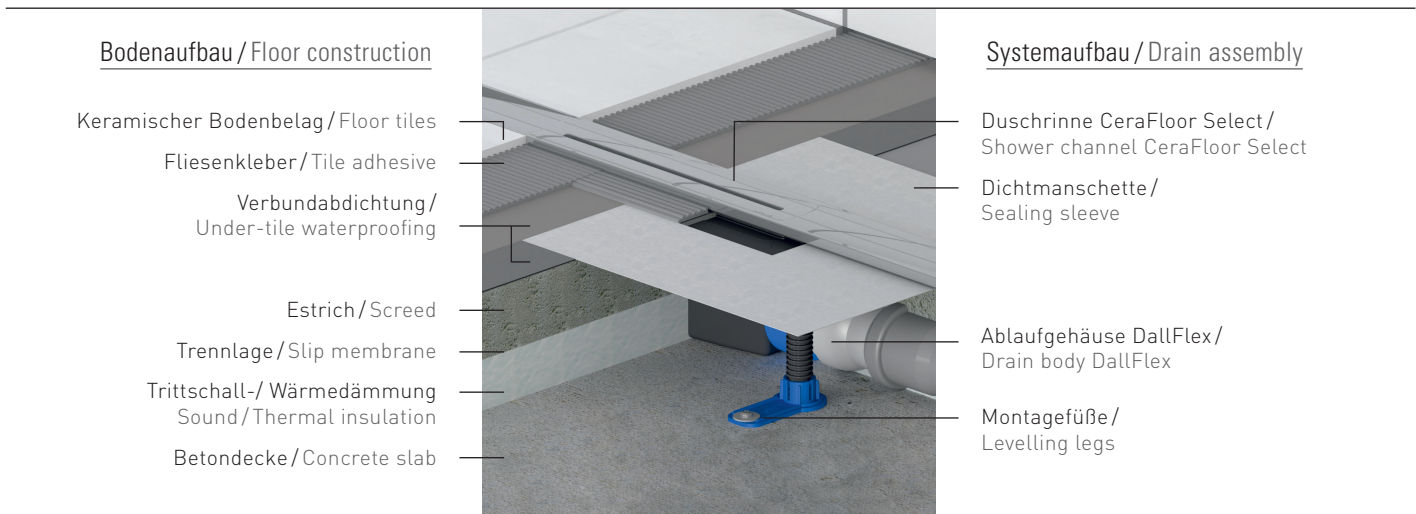

### Duschrinne CeraFloor Select / Shower channel CeraFloor Select

- Länge: 800 mm
- Mit eingefrästem Quergefälle
- Flächenbündige, offene Wasserführung
- Geeignet für Bodenbeläge von 10 - 32 mm (inkl. Kleberbett)
- Length: 800 mm
- With integrated cross-fall
- Flush, exposed channel flow
- Suitable for floor finish 10 to 32 mm (including adhesive)

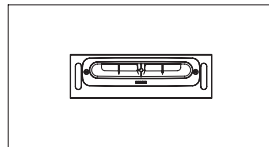
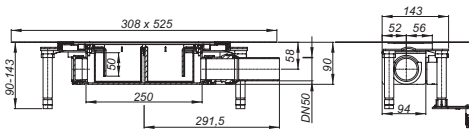
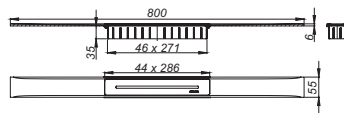

### Ablaufgehäuse DallFlex / Drain body DallFlex

- Maße: 445 × 143 mm
- Bauhöhe: 90 mm
- Bodenaufbau: 90 - 143 mm
- Dimensions: 445 × 143 mm
- Build-in height: 90 mm
- Floor structure: 90 to 143 mm

### Ihre Berechnung / Your calculation

Bodenbelag / Floor slab	mm
Estrich / Screed	mm
Trittschalldämmung / Sound insulation	mm
Wärmedämmung / Thermal insulation	mm
Aufbau gesamt / Construction height	mm
≥ 100 mm, ≤ 175 mm	

Bodenaufbau 90 - 143 mm → 10 - 32 mm

### Ausführung / Standard details

	DN 50	Kunststoff Plastic			0,8 l/s	R 30/60/90/120	DIN 18534	1		L 15
	DN 70						DIN 18534	2		K 3
	DN 100							55x800 mm	R 12	
									B	

Produktnorm: DIN EN 1253 / standard: DIN EN 1253  
Gewicht: 5,77 kg / weight: 5.77 kg

Legende Piktogramme Seite 3 / legend icons page 3

## Einsatzbereich:

### Bodengleiche Dusche / Nassraum

Die wasserableitende Einheit der Duschrinne CeraFloor Select liegt oberhalb der Verbundabdichtungen gemäß DIN 18534, grundsätzlich vorzusehen bei Boden- und Wandflächen im direkt beanspruchten Bereich (z. B. Wände im Duschbereich, Fußböden bodengleicher Duschen).

## Farbvarianten CeraFloor Select

Die Duschrinne CeraFloor Select ist in fünf Farbvarianten erhältlich: Edelstahl matt, Edelstahl poliert, Anthrazit matt, Rotgold matt und Messing matt.

## Baulängen

800 – 1500 mm, Längen ab 1600 mm in 50 mm Schritten durch Reihung.

## Installation detail:

### Level access showers and wet rooms

Using CeraFloor Select means the water draining component is always entirely above the tanking layer.

## Colour variants CeraFloor Select

The shower channel CeraFloor Select is available in five colour variants: stainless steel matt, stainless steel polished, anthracite matt, red gold matt and brass matt.

## Lengths

800 to 1500 mm, lengths above 1600 mm to be realised by combination of several CeraFloor shower channels.



CeraFloor Select matt/matt



CeraFloor Select poliert/polished



CeraFloor Select anthrazit/anthracite matt



CeraFloor Select rotgold/red gold matt



CeraFloor Select messing/brass matt

ARTIKEL ARTICLE	ART. NR. PART NO.	KATALOG CATALOG	SEITE PAGE
<b>Ablaufgehäuse DallFlex / Drain body DallFlex</b> Material: Polypropylen, hochschlagfest, mit Kugelgelenk, verstellbar von 0 – 15 Grad Material: polypropylene, ball-joint adjustable 0 – 15 degrees	539007	Neue Badwelten New bathroom landscapes	30 28
<b>Duschrinne CeraFloor Select 800 mm / Shower channel CeraFloor Select 800 mm</b> Edelstahl matt: Edelstahl 1.4301 / Stainless steel matt: 304 stainless steel Edelstahl poliert: Edelstahl 1.4301 / Stainless steel polished: 304 stainless steel Anthrazit matt: Edelstahl 1.4301, farbig PVD-beschichtet / Anthracite matt: 304 stainless steel, PVD coating Rotgold matt: Edelstahl 1.4301, farbig PVD-beschichtet / Red gold: 304 stainless steel, PVD coating Messing matt: Edelstahl 1.4301, farbig PVD-beschichtet / Brass matt: 304 stainless steel, PVD coating	538000 538109 538239 538307 538376	Neue Badwelten New bathroom landscapes	50 – 58 44 – 52

**Im Lieferumfang enthalten:** Ablaufgehäuse mit integrierter Estrichverankerung, vorgefertigter Randdämmstreifen, schallentkoppelte Justierschrauben zur Höhenverstellung, herausnehmbarer Geruchs- und Reinigungsverschluss, Bauschutzdeckel, Dichtmanschette

**Bestellhinweis:** Bitte Ablaufgehäuse DallFlex + Duschrinne CeraFloor Select bestellen!

**Included:** Drain body for integrated anchors for extra grip in the screed, accessoires for sound-insulated installation, sound absorbing and height-adjustable levelling legs, removable trap insert, temporary blanking plate, sealing sleeve

**Order note:** Please order drain body DallFlex + shower channel CeraFloor Select as two components!

[Download DXF:](http://www.dallmer.de/dxf) www.dallmer.de/dxf

[BIM Daten:](http://www.dallmer.de/bim) www.dallmer.de/bim

[Gebührenfreie Infoline:](tel:+498003255637) + 49 800 (DALLMER) 3255637















[Ausschreibungstexte:](http://www.dallmer.de/ausschreiben) www.dallmer.de/ausschreiben

[Download DXF:](http://www.dallmer.de/en/dxf) www.dallmer.de/en/dxf

[BIM files:](http://www.dallmer.de/en/bim) www.dallmer.de/en/bim

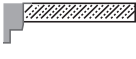
[Freephone infoline:](tel:+498003255637) + 49 800 (DALLMER) 3255637

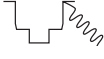
# Piktogramme / Icons

	Ablaufgehäuse senkrecht/seitlich	floor drain body vertical/horizontal
	mit/ohne Geruchsverschluss	with/without trap
DN 50, DN 70, DN ...	Nennweite	nominal diameter
Kunststoff, Edelstahl plastic, stainless steel	Material des Ablaufgehäuses	drain body material
	Ablaufleistung	flow rate
<b>R</b> 30/60/90/120	Brandschutz	fire protection
1  2 	ein oder zwei Abdichtungsebenen	one or two waterproofing membranes
DIN 18534	Verbundabdichtung gemäß DIN 18534	waterproofing confirming to DIN 18534 or other approved standard
 150×150 mm	Rost mit/ohne Verschraubung, Rahmengröße	grate secured /not secured, dimension of frame
	CeraNiveau Aufsatz	CeraNiveau grating
	CeraLine Abdeckungen, Standard, Design und Individual	CeraLine cover plate, Standard, Design and Individual
	Duschrinne CeraFloor Select	shower channel CeraFloor Select
	Duschrinne CeraWall Select	shower channel CeraWall Select
	Duschrinne CeraWall Individual	shower channel CeraWall Individual
L 15 K 3 R 12 B	Belastungsklassen Aufsatz mit Rost: L 15 – 1,5 t K 3 – 300 kg R 12 – rutschhemmend B – rutschhemmend	Loadings: L 15 – 1.5 t K 3 – 300 kg R 12 – non slip B – non slip
	Betondecke	concrete
	Trapezblechdecke	profiled steel
 Druckstrom/Siphonic	SuperDrain® Druckstromentwässerung	SuperDrain® siphonic roof drainage
 beheizt 230V /heated 230V	Ablaufgehäuse beheizt 230V-Stromanschluss	heated drain body 230V-operating voltage
	Frostsichere Geruchssperre, Pendelklappe	frost-proof self-closing flap-valve